

# TABLE OF CONTENTS

Notices .....	Page 1
FCC Notice	
System Scope of Use and Warnings	
System Installation and Usage	
Reacting To Alerts	
Use of Chemicals	
1. Technical Specifications .....	Page 2
Sensor/Transmitter Module	
Display/Receiver Module	
2. Components Part List .....	Page 3
3. Getting Started .....	Page 4
How it works	
Handling Alerts	
4. Sensor/Transmitter Module .....	Page 5
Installation	
Tools Required	
Installing Sensor/Transmitter Module .....	Page 6
5. Display/Receiver Module .....	Page 7
LCD Display	
Installation	
Recommended Installation for Display / Receiver Module .....	Page 8
6. Programming .....	Page 9
Display Mode (S-1) .....	Page 10
Programming Threshold Setting (S-2) .....	Page 11
Sensor ID Exchange Mode (S-3) .....	Page 12
Sensor ID Learning Mode (S-4) .....	Page 13
Turn Backlight On/Off (S-5) .....	Page 14
Activate Spare Tire On/Off (S-6) .....	Page 14
7. Troubleshooting .....	Page 15
8. Appendix & Glossary .....	Page 15
9. Annex .....	Page 16

The manufacturer reserves the right to change the contents of this manual at any time without prior notice. The information contained in this manual is proprietary and must not be reproduced without prior consent from the manufacturer.

## NOTICE

### FCC Notice

This device complies with Part 15 of the FCC Rules. Operation is subject to the following two conditions: (1) this device may not cause harmful interference, and (2) this device must accept any interference received, including interference that may cause undesired operation.

This equipment has been tested and found to comply with the limits for a Class B digital device, pursuant to Part 15 of the FCC Rules. These limits are designed to provide reasonable protection against harmful interference in a residential installation. This equipment generates uses and can radiate radio frequency energy and, if not installed and used in accordance with the instructions, may cause harmful interference to radio communications. However, there is no guarantee that interference will not occur in a particular installation.

If this equipment does cause harmful interference to radio or television reception, which can be determined by turning the equipment off and on, the user is encouraged to try to correct the interference by one or more of the following measures:

- Reorient or relocate the receiving antenna.
- Increase the separation between the equipment and receiver.
- Connect the equipment into an outlet on a circuit different from that to which the receiver is connected.

Caution: Any changes or modifications in construction of this device which are not expressly approved by the party responsible for compliance could void the user's authority to operate the equipment.

### System Scope of Use and Warnings

#### Tire Pressure Monitoring System (TPMS)

This system is a sensing device designed to measure and display tire operation and/or activate an alert to the driver when pressure and temperature irregularities are detected. It is the responsibility of the driver to react promptly and with discretion to alerts. Abnormal tire inflation pressure should be corrected at the earliest opportunity.

#### System Installation and Usage

Use of the TPMS requires that it has been properly installed by qualified personnel according to the instructions here.

This system is suitable for use in passenger car, SUV and 4X4 tires up to maximum cold inflation pressure of 450 Kpa (or 65 Psi).

#### Reacting to Alerts

When an alert or warning is received, reduce vehicle speed and proceed to a safe stop location where the tire can be inspected and/or serviced.

The *low-pressure alert* indicates that the air pressure has dropped to a selected minimum and a *high-temperature alert* indicates that the temperature of the tire content has surpassed the threshold value set.

#### Use of Chemical

Temporary resealing or re-inflation products containing internal sealants or propellants in any tire assembly may adversely affect the operation of the Sensor/Transmitter.

## 1. TECHNICAL SPECIFICATION

<b>Sensor / Transmitter Module</b>	
Operating Temperature Range	-40°C to +125°C
Operating Humidity	100%
Weight	34 gram
Size (LxWxH)	71 mm x 36 mm x 21 mm
Battery Life (Projected)	5 years in normal use
Transmitting Frequency	433.92 MHz / 315 MHz
Transmitter Activation	By pressure change

Table 1

<b>Display/Receiver Module</b>	
Power Supply	9 ~ 15 V DC
Current Consumption	18mA nominal, 130mA during alert @ 12V DC.
Operating Temperature Range	-40°C to +85°C
Weight	95 gram
Size (LxWxH)	18mm x 125mm x 33mm
Receiving Frequency	433.92 MHz / 315 MHz
Monitored Temperature Range	-40°C ~ 125°C (-40°F ~ 257°F)
Monitored Pressure Range	0 ~ 450 Kpa (Accuracy: ± 10 Kpa) 0 ~ 65 Psi (Accuracy: ± 1.5 Psi)

Table 2

## 2. COMPONENTS PART LIST

After unpacking, ensure that all the parts listed below are available. Should any part(s) is/are found missing, please return to your dealer and get a complete replacement set.

Item	Description	Quantity
1	TPMS DISPLAY MODULE ASSY	1
2	DISPLAY MODULE BRACKET	1
3	TPMS SENSOR MODULE ASSY *	4
4	TPMS POWER CABLE ASSY	1
5	SENSOR TAGS (YELLOW, RED, BLUE, GREEN, WHITE*)	4
6	TIRE VALVE **	4
7	VALVE SCREW M5 x 12 **	4
8	ALLEN KEY M4	1
9	TX Washer	1
10	TPMS OWNER'S MANUAL	1

\* Optional 1pc for Spare Tire available

\*\* Use only provided tire valve and screw.

Item 6 – Metal Valve

Item 7 – Valve Screw M5 x 12 with center holes

For replacement parts, quote the description, part code and quantity required when ordering.

 <p>Item 1, 2</p>	 <p>Item 3</p>	 <p>Item 4</p>
 <p>Item 5</p>	 <p>Item 6, 7, 8, 9 &amp; 10</p>	 <p>Item 11</p>

### 3. GETTING STARTED

#### How it works

Pressure and temperature information are sent to the Receiver and displayed on the LCD display. When an under-inflated, over-inflated or over-heated tire is detected, the Receiver will emit an audible warning and activate the backlight to warn the driver. The alerts depend on threshold value set for pressure and temperature. Either the factory or manual preset value can be selected.

#### Handling Alerts

When any of the tires is not within the threshold limits (e.g. under inflated or over heated, the following will occur:

- An audible warning will be activated for a period of 10 seconds at the first occurrence.
- The backlight of the LCD display would be activated for 20 seconds at the first occurrence.
- Low/High Pressure Alert: Pressure Alert indicator (Yellow) of the module turn ON permanently.
- Initial Low Pressure Alert: Pressure Alert indicator (Yellow) of the module will blink.
- High Temperature Alert: Temperature Alert indicator (Yellow) of the module turns ON permanently.
- Tire icon will blink at the faster rate.

The above conditions will persist until the threshold returns to their corresponding preset value.

All TPMS unit comes with the following factory-preset value:

- a. *Initial Low Pressure Alert* when tire pressure is greater than **140Kpa** but lesser or equal to **160Kpa (23Psi)** before Low Pressure Alert)
- b. *Low Pressure Alert* when tire pressure is lesser or equal to **140 Kpa (20 Psi)**
- c. *High Pressure Alert* when tire pressure is greater or equal to **300 Kpa (44 Psi)**
- d. *High Temperature Alert* when tire temperature is greater than **80°C (176°F)**

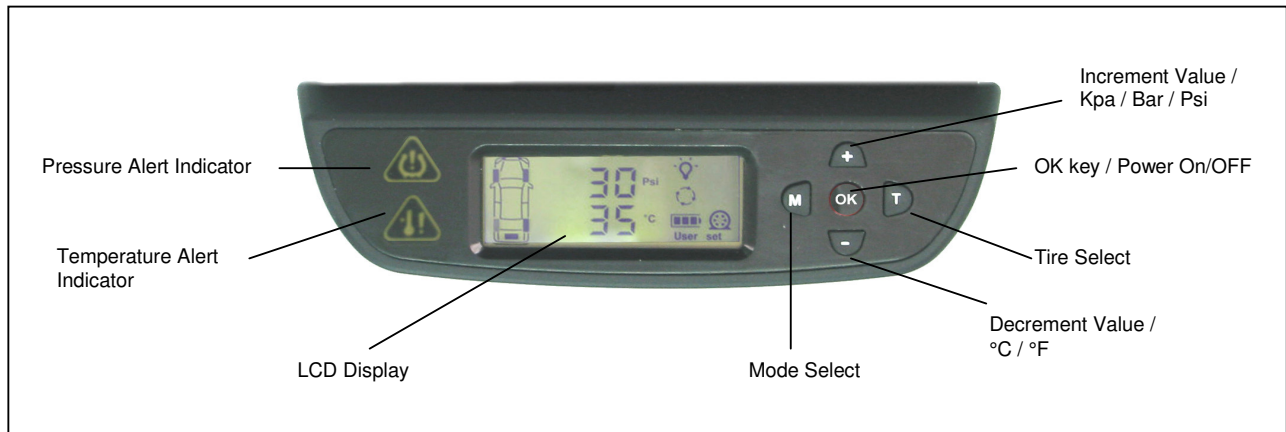

Figure 1  
Display/Receiver Module

#### 4. SENSOR/TRANSMITTER MODULE

##### Installation

**Caution:** Qualified personnel must perform the following installation procedures to ensure that the Sensor/Transmitter Module are properly installed and undamaged. It does not include any standard procedures normally required in the process of replacing a tire but due care should be taken to ensure that the sensors are not damaged.

##### Tools Required

- Tire changing equipment
- Tire balancing equipment
- Socket Wrench (Size M10)
- Allen key (Size M4)



Figure 2 Sensor Module

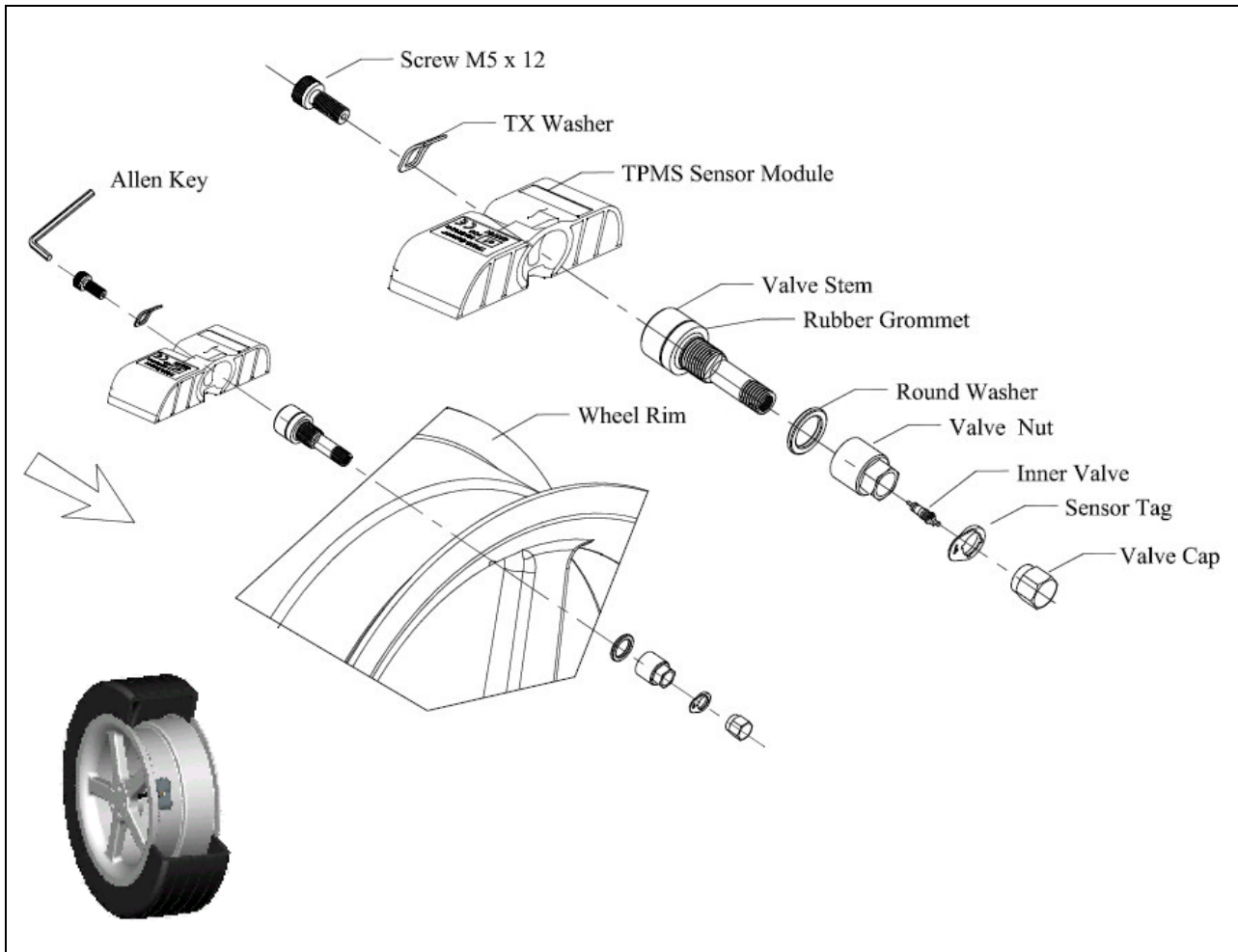

Figure 2a – How to Install Sensor Module with Tire Valve

## Installing Sensor/Transmitter Module

The following is suggested installation sequence:

Transmitter	Wheel Position
Red (1)	Left Front
Yellow (2)	Right Front
Blue (3)	Right Rear
Green (4)	Left Rear
White (5)	*Spare Tire

Table 5

- Remove the original tire valve from tire rim.
- Insert the provided Valve Stem with Rubber Grommet into rim valve hole (Figure 3a). Insert the Round Washer and Valve Nut to the Valve Stem as shown in Figure 3b & 4a.
- Hold the Valve Stem in position during the Valve Nut tightening process (Figure 4b).
- Tighten the Valve Nut with Socket Wrench (Size M10). *Ensure* that the Valve Nut is properly tightened to the Valve Stem (Figure 5a).
- Position the Sensor/Transmitter Module to mount on Valve Stem and insert the provided TX Washer (Figure 5b), then finally insert the Screw M5 x 12 through the Sensor/Transmitter Module as shown in Figure 6a.
- Fix the Sensor/Transmitter Module to the Valve Stem with Allen key (Size M4). *Ensure* that the screw is properly tightened to hold the Sensor/Transmitter Module (Figure 6b).
- Attach the corresponding color tag to the Valve Stem and secure it with the Valve Cap by carefully twisting the Sensor Tag onto the Valve Stem. See Figure 7a and Figure 7b.
- The tire valve will be the reference position of the Sensor/Transmitter Module location in order not to damage when installing or removing tire from the wheel.
- Proceed to mount the tire onto the wheel.
- Ensure that the tires are properly re-balanced.



Figure 3a



Figure 3b



Figure 4a



Figure 4b



Figure 5a



Figure 5b



Figure 6a



Figure 6b

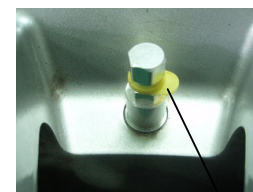

Figure 7a



Figure 7b

#

# = The tag (Figure 7a) should correspond to the sensor model stated in Table 5 above.

\*Optional Part

### Note

1. Ensure that each of the color tag correspond to the number marking on the Sensor/Transmitter. Refer Table 5 for the corresponding Sensor Tag to tire. Keep the colored Sensor Tag on the Valve Stem for installation and tire rotation.
2. Rubber Grommet on Valve Stem shall be replaced with a new one whenever doing tire replacement or the rubber grommet is found defective and cause air leaking.

## 5. DISPLAY/RECEIVER MODULE

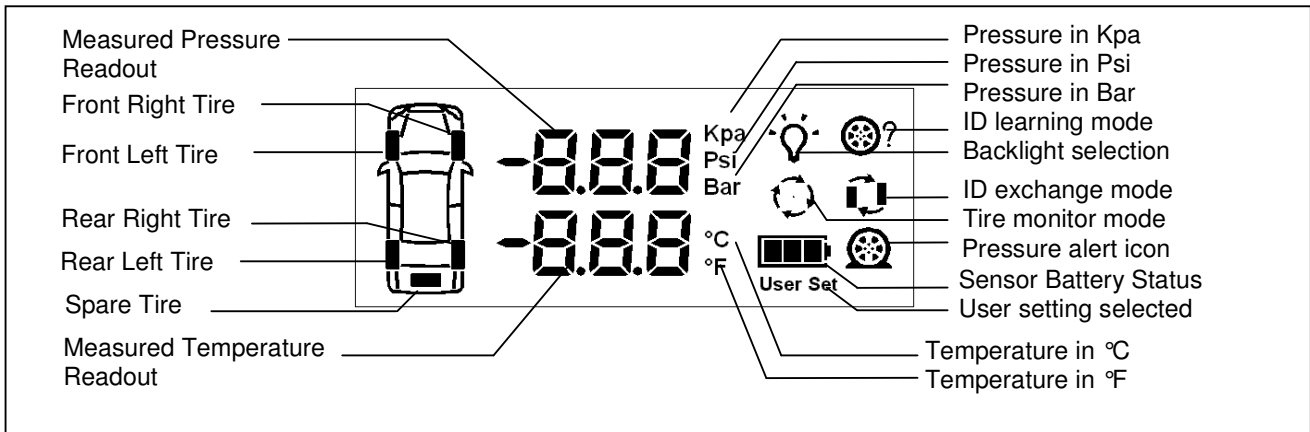

Figure 8 LCD Display

### Installation

1. Insert the Power Supply Cable connector into Receiver socket, which is located at the top rear (Figure 9).
2. Connect the other end of the Power Supply Cable to the vehicle **+12VDC**, **Ground** and **ACC** (Figure 10).



Figure 9 Connection of Power Cable

RED color wire to vehicle **+12V DC**,  
 BLACK color wire vehicle **Ground**,  
 ORANGE color Wire to vehicle **ACC**,

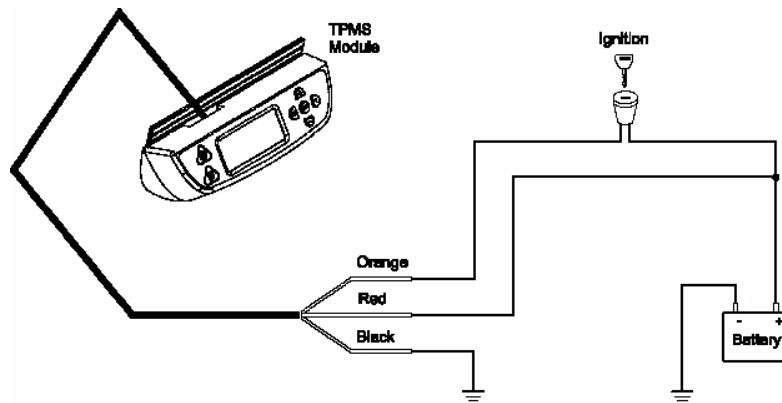

Figure 10 Wiring Diagram



**Recommended Installation for Display/Receiver Module and Bracket**

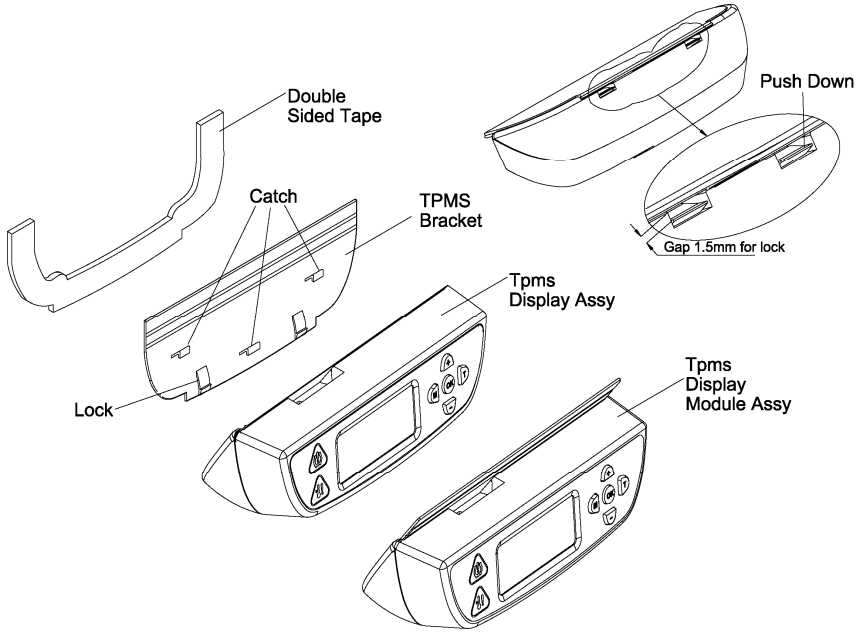

Figure 11

1. Determine the desired location for Display/Receiver Module. Refer Figure 12 for possible locations
2. Peel off the film covering the piece of black adhesive double-sided-tape film on the back of the display bracket. (Figure 13)
3. Mount the Display/Receiver Module to the desired location. (Figure 14)
4. Apply pressure around the Display/Receiver Module for maximum mounting of the module to the car windscreen. (Figure 15)
5. If the module did not fix well to the windscreen, take out the Display/Receiver Module from the bracket. (Figure 16 and Figure 17)
6. Apply pressure around the bracket panel for maximum mounting of the bracket to the car windscreen. (Figure 18)
7. Install back the Display/Receiver Module to the bracket. (Figure 19)



Figure 13



Figure 14



Figure 15



Figure 16

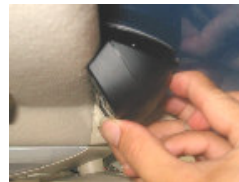

Figure 17



Figure 18



Figure 19

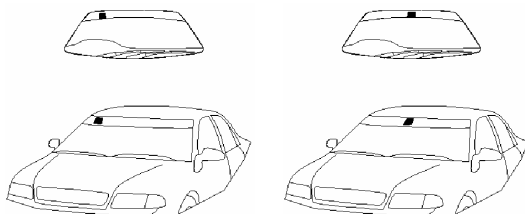

Figure 12

## 6. PROGRAMMING

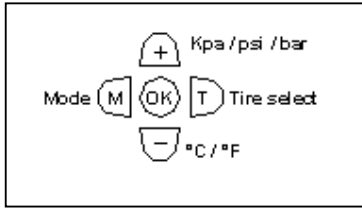







Figure 20

- ❖ To Enter Programming Mode Main Menu
  1. *Ensure that the power is switched ON*
  2. *Press and hold [M] button for 3 sec or more*
  
- ❖ In programming mode toggle the [+ ] or [- ] button for desired programming mode from S-1 to S-6.
  -  S - 1 : ror / n oL  
Rotation or normal mode
  - User Set  S - 2 : Usr / FAC  
User setting or factory default Mode
  -  S - 3 : Ech  
ID exchange mode
  -  S - 4 : LEr  
ID learning mode
  -  S - 5 : LIg  
Back light On/Off
  -  S - 6 : SPr  
Spare tire On/Off
  
- ❖ To accept the desired programming mode press [OK] button.
  
- ❖ To Quit Programming Main Menu Display mode, press and hold [M] button for 3sec or more.

### Display Mode (S- 1)

Press [OK] to enter programming display mode. 'ror' or 'noL' will blink to indicate that it is ready to accept changes. Toggle [+] or [-] button to alternate between Rotation Mode and Normal Mode.

#### Rotation Mode

Each of the tires will be 'scanned' for the reading. The rotation will begin from Front Left tire, followed by Front Right Tire, Rear Right Tire, Rear Left Tire and the cycle will begin again with the Front Left Tire. This is indicated by a blinking tire icon.

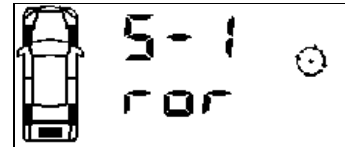
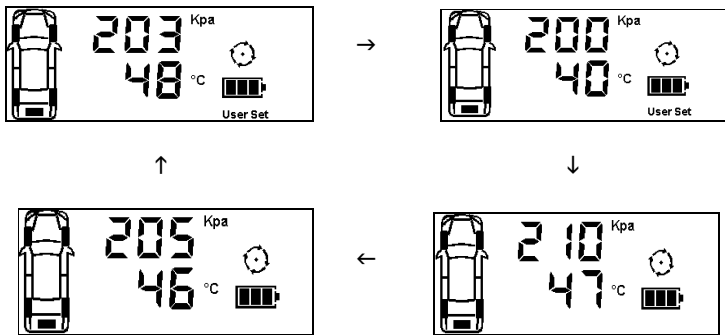

Figure 21  
Rotation Mode Activated

#### Normal Mode

In the normal mode, the display will always show information of the tire with the lowest pressure value. The rotation mode tire symbol will be disabled indicating the selected mode is normal mode. (Refer to figure 23 & 24)  
To view information of other tires, press [T] button.

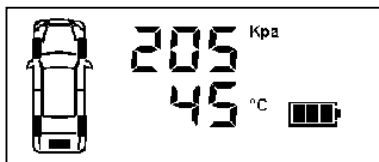

Figure 24

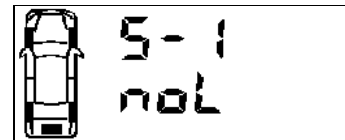

Figure 23  
Normal Mode Activated

#### Note

Value shown is for reference only.

### Programming Threshold Setting (S- 2)

Press [OK] to enter the Threshold Setting Mode.  
There are two available threshold setting mode available,  
1. User setting (USr)  
2. Factory Default (FAC)



Figure 25

Upon entering this mode, the selected threshold setting mode will blink, indicating that the currently selected mode and it is ready to accept changes of the mode. Pressing the [ + ] button or [ - ] button to toggle the mode to USr or FAC. (refer Figure 26)



Figure 26

### Factory Default

To use the factory default mode, toggle [+] or [-] button till the 'FAC' setting blinks.

1. Press [OK] to view the factory default for High Pressure Alert,
2. Press [OK] second time for Low Pressure Alert and press [OK] the third time for Temperature Threshold Alert. Finally press [OK] again to accept and select the Factory Default Setting.



Figure 27

### Note

All TPMS unit comes with a Factory-Preset Value of **140 Kpa (20 Psi)** for the Low Pressure Alert, **300 Kpa (44 Psi)** for High-Pressure Alert and **80°C (176°F)** for the High Temperature Alert

### User Setting

1. Press M button for 3 seconds or more to enter main menu.
2. After the display has entered main menu, press + button to go to S-2 (User Set)
3. Press OK button.
4. Press + or - button to go to User Set (User will blink indicating you have entered this mode)
5. Press OK button and the Higher Pressure Alert will be ready (HI)
6. Press + to increase and - to decrease the value.
7. Press OK button after confirming first digit and repeat step 6 for the remaining digits.
8. After pressing OK for the last digit, it will automatically go into Low Pressure Alert (LO) setting.
9. Repeat steps 6 and 7.
10. Again after pressing OK for the last digit, it will automatically go into High Temperature Alert.
11. If you do not wish to change this setting, just press OK until it exits this mode.
12. If you wish to change this setting too, repeat steps 6 and 7.
13. To return to normal mode, press M button for 3 seconds again.



Figure 28



Figure 29

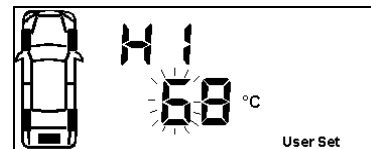

Figure 30

### Note

For low and high pressure alert, the maximum limit is 399Kpa (58 Psi) while for temperature; the maximum limit is 99°C (210°F).  
To confirm the selected value, press the [OK] button to save it.

### Note

1. Value shown is for reference only.
2. The setting of Manual Threshold Setting can only be done in Kpa (Pressure) and °C (Temperature).  
Refer to Annex 1 & 2 for conversion between the units.

### Sensor ID Exchange Mode (S- 3)

After rotation of tires, the Sensor ID data in the receiver must be changed accordingly to ensure that it indicates the correct tire when there are any irregularities.

#### Step 1

Press [OK] button to enter ID Exchange Mode.



Figure 31

#### Step 2

The Front left tire icon and its corresponding ID digit will blink.

1. Use [+] and [-] button to change the selected Sensor ID digit.
2. Press [OK] to confirm the changes and the next ID digit will blink accordingly.
3. Repeat step 1 and 2 for all other ID digits.
4. The ID number '5' will only be available if the spare tire setting is 'ON'



Figure 32

#### Step 3

Press [T] button to quit the ID Exchange Mode without saving and return back to Programming Main Menu Display.

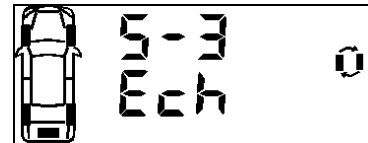

Figure 33

#### Step 4

The receiver will return back to Programming Main Menu Display and that complete the process of exchanging Sensor ID data in the receiver.

#### Note

The receiver will not save the information if any of the tires are found to have identical Sensor ID.

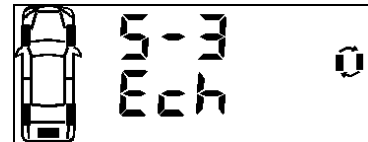

Figure 34

#### Note

1. Value shown is for reference only.

### Sensor ID Learning Mode (S- 4)

For programming of a new receiver unit with ID Learning Mode, refer to the following steps.

#### Step 1

Press [OK] button to enter the ID Learning Mode.

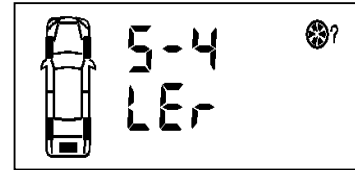

Figure 35

#### Step 2

1. The front left tire icon will blink. Toggle [+] or [-] button to select the desired tire and press [OK] to accept the desired location. The corresponding tire ID number blinks (once per second) to indicate that it is ready to accept new Sensor ID input.
2. Inflate or deflate the corresponding tire by at least 28Kpa (4Psi).
3. When the new ID code is received, the tire icon will blink at a faster rate (twice per second); the ID number stops blinking and the module will beep for 5 second.
4. Press [OK] button to save the sensor ID.
5. Repeat Step 1 to 3 for other tire sensor(s) that needs to be replaced.



Figure 36

#### Note

ID '5' will only be able to receive sensor signal if the Spare Tire setting is ON. (Refer to Spare Tire ON/OFF Mode (S- 6))

#### Step 3

Press [T] button to return to Programming Main Menu Display.

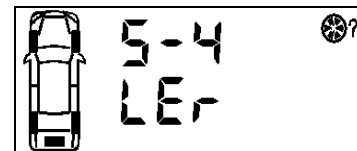

Figure 37

#### Note

1. The receiver will not save any identical Sensor ID.
2. Value shown is for reference only.

### Turn Backlight ON/OFF (S- 5)

For programming backlight setting, refer to the following steps.

1. Backlight ON (Permanent ON)
2. Backlight OFF (Auto)

#### Step 1

Press [OK] button to enter Backlight Programming Mode.



Figure 38

#### Step 2

The default-selected option will blink.

1. To change the selection ON-OFF press [+] or [-] button.
2. To confirm the selection press [OK] button.
3. The receiver will return back to Programming Main Menu Display

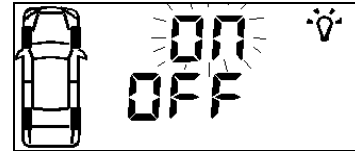

Figure 39

### Activate Spare Tire ON/OFF Mode (S- 6)

For programming Spare Tire setting option, refer to the following steps.

1. Spare Tire ON (Enable Spare Tire monitoring)
2. Spare Tire OFF (Disable Spare Tire monitoring)

#### Step 1

Press [OK] button to enter the Spare Tire Setting Mode.

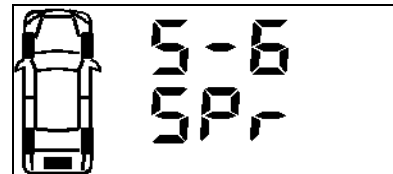

Figure 40

#### Step 2

The default-selected option will blink.

1. To change the selection ON-OFF press [+] or [-] button.
2. To confirm the selection press [OK] button.
3. The receiver will return back to Programming Main Menu Display



Figure 41

## 7. Troubleshooting Guide

Symptoms	Possible cause(s)	Solution
No display on LCD panel.	No power.	Check connections of Power cable at both ends. Ensure that the connection is on the correct polarity and properly grounded.
No display on LCD panel.	Faulty Unit.	Contact your dealer for a replacement.
The unit does not activate when the POWER key button is pressed.	The car ignition has not been turned ON.	Turn the ignition key to ACC position.
The receiver is not learning the ID during ID LEARNING Mode.	Localize RF interference.	Move to another location and re-initiate the ID LEARNING process.
No instant alert	Reverse power cable installation.	Ensure that the red wire is connected to permanent power supply (battery) and orange wire is connected to ACC position of the ignition.
Unable to tighten screw into the tire valve	Check tire valve thread	Change tire Valve
Air cannot be pump into the tire	No centre holes on the valve screw	Change to Valve Screw M5x12 with centre holes

## 8. Appendix

### Glossary

Kpa	Pressure reading in kilo Pascal
Psi	Pressure reading in pound per square inch
Bar	Pressure reading in Bar
°C	Temperature reading in degrees Celsius
°F	Temperature reading in degrees Fahrenheit
Cold Pressure	Recommended inflation pressure of a tire at ambient temperature of 22°C by vehicle manufacturers.
Low Pressure Alert	Visual and audible warning that is activated when the tire's pressure goes below the preset level.
Initial Low Pressure Alert	Visual and audible warning activated when tire pressure reaches the region of 50Kpa before Low Pressure Alert (e.g. Factory Setting, Low Pressure Alert is set to 140Kpa, which means Initial Low Pressure Alert is when pressure is above 140Kpa, but below 160Kpa.
Display/Receiver Module	The electronic module mounted inside the vehicle that alerts the driver of any tire irregularities.
Sensor/Transmitter Module	The electronic module mounted on the wheels that measure the air pressure and temperature of the tire.



9. Annexes

**Annex I**

Psi To Kpa To Psi Conversion Table

<b>Kpa to Psi Conversion Table</b>							
<b>Kpa</b>	<b>Psi</b>		<b>Kpa</b>	<b>Psi</b>		<b>Kpa</b>	<b>Psi</b>
10	1		210	31		410	60
20	3		220	32		420	61
30	4		230	34		430	63
40	6		240	35		440	64
50	7		250	37		450	66
60	9		260	38		460	67
70	10		270	39		470	69
80	12		280	41		480	70
90	13		290	42		490	72
100	15		300	44		500	73
110	16		310	45			
120	18		320	47			
130	19		330	48			
140	20		340	50			
150	22		350	51			
160	23		360	53			
170	25		370	54			
180	26		380	55			
190	28		390	57			
200	29		400	58			

**Annex II**

°C To °F To °C Conversion Table

<b>°C to °F Conversion Table</b>							
<b>°C</b>	<b>°F</b>		<b>°C</b>	<b>°F</b>		<b>°C</b>	<b>°F</b>
-40	-40		20	68		80	176
-30	-22		30	86		90	194
-20	-4		40	104		100	212
-10	14		50	122		110	230
0	32		60	140		120	248
10	50		70	158		125	257

This Page is Intentionally Left Blank

This Page is Intentionally Left Blank

This Page is Intentionally Left Blank